

CATALOGO GENERALE
GENERAL CATALOGUE
CATALOGUE GÉNÉRAL
GESAMTKATALOG

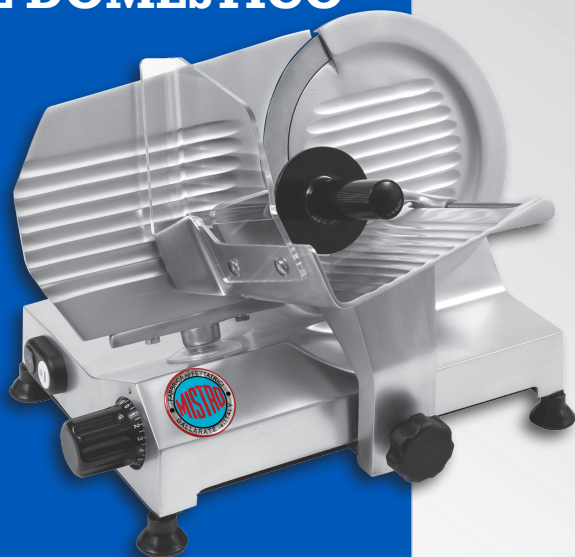

A large, stylized watermark of the "MISTRO" logo is positioned in the bottom right corner. The letters are black with a prominent red and blue outline, matching the colors of the main logo. The watermark is partially enclosed by a large, faint circular outline that spans across the bottom half of the page.

GS 200 CE DOMESTICO





GS 220 CE DOMESTICO



GS 220 SPECIAL CE



	GS 200 CE DOMESTICO	GS 220 CE DOMESTICO	GS 220 SPECIAL CE
LAMA - KNIFE - LAME - MESSER	200 mm	220 mm	220 mm
SPESORE DI TAGLIO CUTTING THICKNESS ÉPAISSEUR DE COUPE SCHNITTSTÄRKE	15 mm	15 mm	15 mm
CAPACITÀ DI TAGLIO CUTTING CAPACITY CAPACITÉ DE COUPE DES PRODUITS SCHNEIDLEISTUNG	 130 x 160 mm  130 mm	 160 x 210 mm  160 mm	 160 x 210 mm  160 mm
CORSA CARRELLO CARRIAGE STROKE COURSE CHARIOT WAGEN-HUB	190 mm	240 mm	240 mm
PIATTO PLATE PLATEAU SCHNEIDEGUTAUFLEGE	165 x 150 mm	195 x 180 mm	195 x 180 mm
MISURE INGOMBRO OVERALL SIZE DIMENSIONS D'ENCOMBREMENT HÖCHSTABMESSUNGEN	410 x 360 x 290 mm	510 x 400 x 340 mm	510 x 400 x 360 mm
BASE CENTRO PIEDI BASE FEET CENTRE BASE CENTRE PIEDS AUF STELL-FLÄCHE	330 x 230 mm	390 x 280 mm	390 x 280 mm
PESO NETTO NET WEIGHT POIDS NET EIGEN-GEWICHT	10 Kg	13,5 Kg	13,5 Kg
MISURE IMBALLO PACKING SIZE DIMENSIONS EMBALLAGE ABMESSUNGEN VERPACKUNG	440 x 410 x 350 mm	480 x 420 x 380 mm	480 x 420 x 380 mm
PESO LORDO GROSS WEIGHT POIDS BRUT BRUTTO GEWICHT	12 Kg	15,5 Kg	15,5 Kg

	GS 200 CE DOMESTICO	GS 220 CE DOMESTICO	GS 220 SPECIAL CE
MOTORE MOTOR MOTEUR MOTOR	MONOFASE SINGLE PHASE MONOPHASÉ EINPHASIG	MONOFASE SINGLE PHASE MONOPHASÉ EINPHASIG	MONOFASE SINGLE PHASE MONOPHASÉ EINPHASIG
VOLTAGGIO VOLTAGE VOLTAGE SPANNUNG	230 V	230 V	230 V
AMPERE AMPERE AMPÈRE AMPERE	0,6 A	0,7 A	0,7 A
POTENZA POWER PUISSANCE LEISTUNG	0,132 Kw	0,154 Kw	0,154 Kw
FREQUENZA FREQUENCY FRÉQUENCE FREQUENCY	50 Hz	50 Hz	50 Hz



DISPONIBILITÀ AFFETTATRICI VERNICIATE COLORI TABELLA RAL
 AVAILABILITY PAINTING OF THE SLICERS IN BASE ON A RAL TABLE
 DISPONIBILITÉ TRANCHEURS EN COLEUR AVEC TABLEAU RAL
 VERFÜGBARKEIT ANSTRICH SCHNEIDEMASCHINE MIT TABELLE RAL

GS 250 E CE

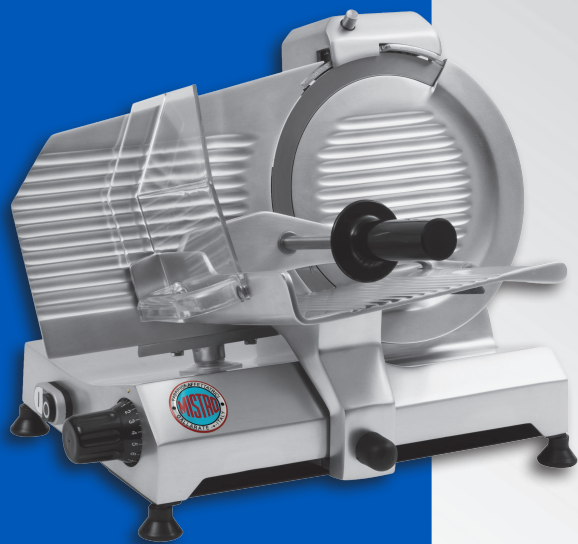

	GS 250 E CE	GS 250 E CM10 CE	GS 250 CM10 CE
LAMA - KNIFE - LAME - MESSER	250 mm	250 mm	250 mm
SPESORE DI TAGLIO CUTTING THICKNESS ÉPAISSEUR DE COUPE SCHNITTSTÄRKE	15 mm	15 mm	15 mm
CAPACITÀ DI TAGLIO CUTTING CAPACITY CAPACITÉ DE COUPE DES PRODUITS SCHNEIDLEISTUNG	165 x 220 mm 180 mm	155 x 220 mm 170 mm	150 x 230 mm 160 mm
CORSA CARRELLO CARRIAGE STROKE COURSE CHARIOT WAGEN-HUB	255 mm	250 mm	280 mm
PIATTO PLATE PLATEAU SCHNEIDEGUTAUFLEGE	220 x 220 mm	220 x 220 mm	250 x 240 mm
MISURE INGOMBRO OVERALL SIZE DIMENSIONS D'ENCOMBREMENT HÖCHSTABMESSUNGEN	565 x 420 x 400 mm	580 x 450 x 370 mm	600 x 500 x 470 mm
BASE CENTRO PIEDI BASE FEET CENTRE BASE CENTRE PIEDS AUF STELL-FLÄCHE	390 x 280 mm	385 x 275 mm	440 x 330 mm
PESO NETTO NET WEIGHT POIDS NET EIGEN-GEWICHT	15 Kg	16 Kg	23 Kg
MISURE IMBALLO PACKING SIZE DIMENSIONS EMBALLAGE ABMESSUNGEN VERPACKUNG	560 x 470 x 420 mm	560 x 470 x 420 mm	660 x 550 x 500 mm
PESO LORDO GROSS WEIGHT POIDS BRÛT BRUTTO GEWICHT	17,5 Kg	18 Kg	27 Kg

GS 250 E CM10 CE



	GS 250 E CE	GS 250 E CM10 CE	GS 250 CM10 CE
MOTORE MOTOR MOTEUR MOTOR	MONOFASE SINGLE PHASE MONOPHASÉ EINPHASIG	MONOFASE SINGLE PHASE MONOPHASÉ EINPHASIG	MONOFASE SINGLE PHASE MONOPHASÉ EINPHASIG
VOLTAGGIO VOLTAGE VOLTAGE SPANNUNG	230 V	230 V	230 V
AMPERE AMPERE AMPÈRE AMPÈRE	0,8 A	0,8 A	0,85 A
POTENZA POWER PUISSANCE LEISTUNG	0,176 Kw	0,176 Kw	0,210 Kw
FREQUENZA FREQUENCY FRÉQUENCE FREQUENCY	50 Hz	50 Hz	50 Hz

GS 250 CM10 CE



DISPONIBILITÀ MOTORE TRIFASE MODELLO GS 250 CM10 CE
 AVAILABILITY THREE PHASE MOTOR MODEL GS 250 CM10 CE
 DISPONIBILITÉ TRIPHASÉ MOTEUR MODÈLE GS 250 CM10 CE
 VERFÜGBARKEIT DREHSTROMMOTOR MODELL GS 250 CM10 CE

GS 275 CE

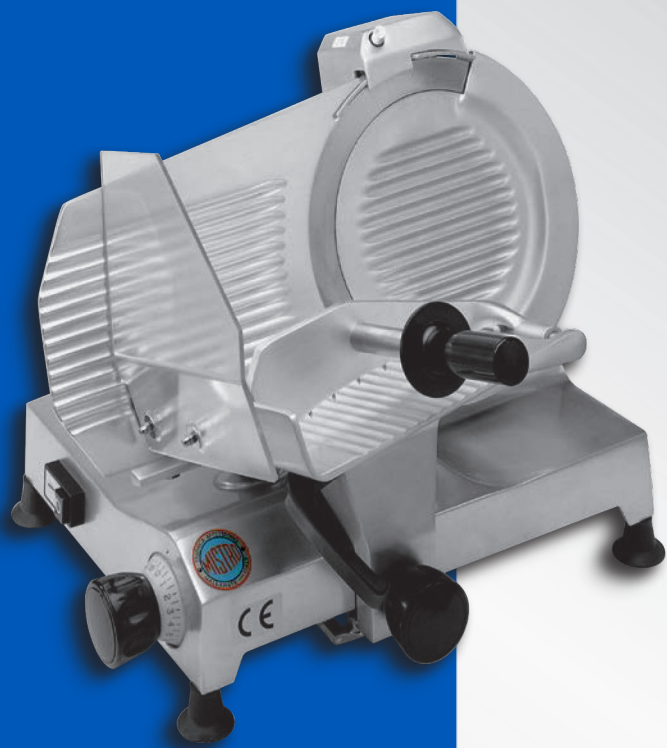

	GS 275 CE	GS 300 CE
LAMA - KNIFE - LAME - MESSER	275 mm	300 mm
SPESORE DI TAGLIO CUTTING THICKNESS ÉPAISSEUR DE COUPE SCHNITTSTÄRKE	15 mm	15 mm
CAPACITÀ DI TAGLIO CUTTING CAPACITY CAPACITÉ DE COUPE DES PRODUITS SCHNEIDLEISTUNG	 165 x 240 mm 180 mm	 180 x 240 mm 190 mm
CORSA CARRELLO CARRIAGE STROKE COURSE CHARIOT WAGEN-HUB	270 mm	270 mm
PIATTO PLATE PLATEAU SCHNEIDEGUTAUFLEGE	250 x 240 mm	280 x 270 mm
MISURE INGOMBRO OVERALL SIZE DIMENSIONS D'ENCOMBREMENT HÖCHSTABMESSUNGEN	610 x 470 x 430 mm	655 x 510 x 450 mm
BASE CENTRO PIEDI BASE FEET CENTRE BASE CENTRE PIEDS AUF STELL-FLÄCHE	440 x 330 mm	440 x 330 mm
PESO NETTO NET WEIGHT POIDS NET EIGEN-GEWICHT	22 Kg	22 Kg
MISURE IMBALLO PACKING SIZE DIMENSIONS EMBALLAGE ABMESSUNGEN VERPACKUNG	660 x 550 x 500 mm	660 x 550 x 500 mm
PESO LORDO GROSS WEIGHT POIDS BRUT BRUTTO GEWICHT	26 Kg	26 Kg

GS 300 CE



	GS 275 CE	GS 300 CE
MOTORE MOTOR MOTEUR MOTOR	MONOFASE SINGLE PHASE MONOPHASÉ EINPHASIG	MONOFASE SINGLE PHASE MONOPHASÉ EINPHASIG
VOLTAGGIO VOLTAGE VOLTAGE SPANNUNG	230 V	230 V
AMPERE AMPERE AMPÈRE AMPERE	1 A	1 A
POTENZA POWER PUISSANCE LEISTUNG	0,220 Kw	0,220 Kw
FREQUENZA FREQUENCY FRÉQUENCE FREQUENCY	50 Hz	50 Hz



DISPONIBILITÀ MOTORE TRIFASE
AVAILABILITY THREE PHASE MOTOR
DISPONIBILITÉ TRIPHASÉ MOTEUR
VERFÜGBARKEIT DREHSTROMMOTOR

GS 300 CM12 CE

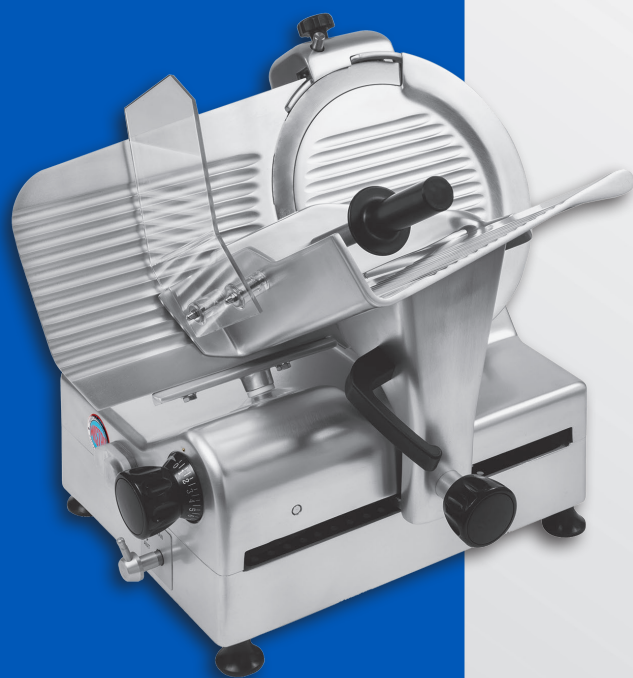

GS 300 CM12 SA CE







	GS 300 CM12 CE	GS 300 CM12 SA CE
LAMA - KNIFE - LAME - MESSER	300 mm	300 mm
SPESSORE DI TAGLIO CUTTING THICKNESS ÉPAISSEUR DE COUPE SCHNITTSTÄRKE	15 mm	15 mm
CAPACITÀ DI TAGLIO CUTTING CAPACITY CAPACITÉ DE COUPE DES PRODUITS SCHNEIDLEISTUNG	 180 x 240 mm 200 mm	 180 x 240 mm 200 mm
CORSA CARRELLO CARRIAGE STROKE COURSE CHARIOT WAGEN-HUB	270 mm	270 mm
PIATTO PLATE PLATEAU SCHNEIDEGUTAUFLEGE	280x270 mm	280x270 mm
MISURE INGOMBRO OVERALL SIZE DIMENSIONS D'ENCOMBREMENT HÖCHSTABMESSUNGEN	660 x 510 x 480 mm	660 x 510 x 550 mm
BASE CENTRO PIEDI BASE FEET CENTRE BASE CENTRE PIEDS AUF STELL-FLÄCHE	440 x 330 mm	415 x 330 mm
PESO NETTO NET WEIGHT POIDS NET EIGEN-GEWICHT	25 Kg	36 Kg
MISURE IMBALLO PACKING SIZE DIMENSIONS EMBALLAGE ABMESSUNGEN VERPACKUNG	660 x 550 x 500 mm	680 x 600 x 650 mm
PESO LORDO GROSS WEIGHT POIDS BRUT BRUTTO GEWICHT	28,5 Kg	39 Kg

	GS 300 CM12 CE	GS 300 CM12 SA CE	GS 300 CM12 SA CE
MOTORE MOTOR MOTEUR MOTOR	MONOFASE SINGLE PHASE MONOPHASE EINPHASIG	MONOFASE SINGLE PHASE MONOPHASE EINPHASIG	CARRO WAGON CHARIOT ABLAGE
VOLTAGGIO VOLTAGE VOLTAGE SPANNUNG	230 V	230 V	230 V
AMPERE AMPERE AMPÈRE AMPERE	1,4 A	1,4 A	1,1 A
POTENZA POWER PUISSANCE LEISTUNG	0,242 Kw	0,242 Kw	0,185 Kw
FREQUENZA FREQUENCY FRÉQUENCE FREQUENCY	50 Hz	50 Hz	50 Hz

DISPONIBILITÀ MOTORE TRIFASE
AVAILABILITY THREE PHASE MOTOR
DISPONIBILITÉ TRIPHASÉ MOTEUR
VERFÜGBARKEIT DREHSTROMMOTOR

GS 300 SPECIAL CE



	GS 300 SPECIAL CE	GS 330 CM13 CE
LAMA - KNIFE - LAME - MESSER	300 mm	330 mm
SPessore di taglio CUTTING THICKNESS ÉPAISSEUR DE COUPE SCHNITTSTÄRKE	15 mm	15 mm
CAPACITÀ DI TAGLIO CUTTING CAPACITY CAPACITÉ DE COUPE DES PRODUITS SCHNEIDLEISTUNG	 150 x 280 mm  190 mm	 195 x 290 mm  230 mm
CORSA CARRELLO CARRIAGE STROKE COURSE CHARIOT WAGEN-HUB	310 mm	325 mm
PIATTO PLATE PLATEAU SCHNEIDEGUTAUFLEGE	280 x 270 mm	280 x 270 mm
MISURE INGOMBRO OVERALL SIZE DIMENSIONS D'ENCOMBREMENT HÖCHSTABMESSUNGEN	690 x 500 x 480 mm	730 x 520 x 480 mm
BASE CENTRO PIEDI BASE FEET CENTRE BASE CENTRE PIEDS AUF STELL-FLÄCHE	510 x 320 mm	505 x 320 mm
PESO NETTO NET WEIGHT POIDS NET EIGEN-GEWICHT	29,5 Kg	28 Kg
MISURE IMBALLO PACKING SIZE DIMENSIONS EMBALLAGE ABMESSUNGEN VERPACKUNG	790 x 620 x 510 mm	790 x 620 x 510 mm
PESO LORDO GROSS WEIGHT POIDS BRUT BRUTTO GEWICHT	34,5 Kg	34 Kg

GS 330 CM13 CE







	GS 300 SPECIAL CE	GS 330 CM13 CE
MOTORE MOTOR MOTEUR MOTOR	MONOFASE SINGLE PHASE MONOPHASE EINPHASIG	MONOFASE SINGLE PHASE MONOPHASE EINPHASIG
VOLTAGGIO VOLTAGE VOLTAGE SPANNUNG	230 V	230 V
AMPERE AMPERE AMPÈRE AMPERE	1,2 A	1,6 A
POTENZA POWER PUISSANCE LEISTUNG	0,264 Kw	0,270 Kw
FREQUENZA FREQUENCY FRÉQUENCE FREQUENCY	50 Hz	50 Hz

DISPONIBILITÀ MOTORE TRIFASE
AVAILABILITY THREE PHASE MOTOR
DISPONIBILITÉ TRIPHASÉ MOTEUR
VERFÜGBARKEIT DREHSTROMMOTOR

GS 350 CE



	GS 350 CE	GS 350 CM14 CE
LAMA - KNIFE - LAME - MESSER	350 mm	350 mm
SPessore di taglio CUTTING THICKNESS ÉPAISSEUR DE COUPE SCHNITTSTÄRKE	15 mm	15 mm
CAPACITÀ DI TAGLIO CUTTING CAPACITY CAPACITÉ DE COUPE DES PRODUITS SCHNEIDLEISTUNG	 210 x 280 mm  240 mm	 210 x 280 mm  240 mm
CORSA CARRELLO CARRIAGE STROKE COURSE CHARIOT WAGEN-HUB	310 mm	315 mm
PIATTO PLATE PLATEAU SCHNEIDEGUTAUFLEGE	280 x 270 mm	280 x 270 mm
MISURE INGOMBRO OVERALL SIZE DIMENSIONS D'ENCOMBREMENT HÖCHSTABMESSUNGEN	690 x 500 x 480 mm	700 x 520 x 470 mm
BASE CENTRO PIEDI BASE FEET CENTRE BASE CENTRE PIEDS AUF STELL-FLÄCHE	510 x 320 mm	510 x 320 mm
PESO NETTO NET WEIGHT POIDS NET EIGEN-GEWICHT	34 Kg	30 Kg
MISURE IMBALLO PACKING SIZE DIMENSIONS EMBALLAGE ABMESSUNGEN VERPACKUNG	790 x 620 x 510 mm	790 x 620 x 510 mm
PESO LORDO GROSS WEIGHT POIDS BRUT BRUTTO GEWICHT	39 Kg	36 Kg

GS 350 CM14 CE

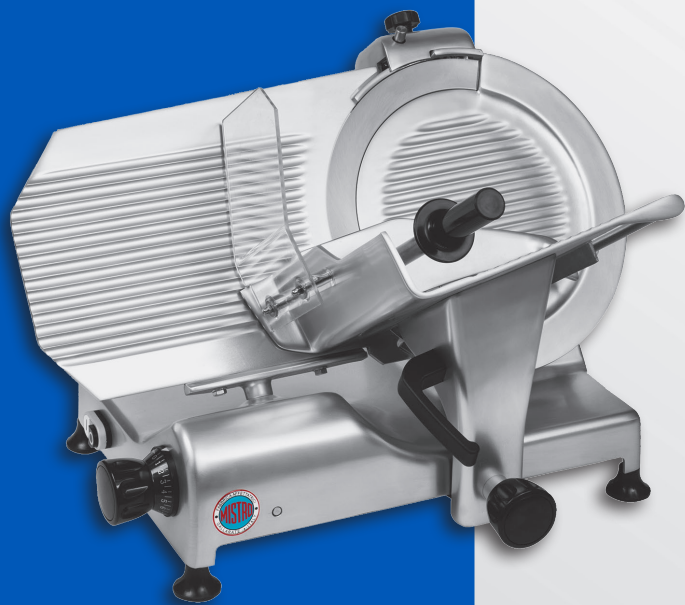



	GS 350 CE	GS 350 CM14 CE
MOTORE MOTOR MOTEUR MOTOR	MONOFASE SINGLE PHASE MONOPHASÉ EINPHASIG	MONOFASE SINGLE PHASE MONOPHASÉ EINPHASIG
VOLTAGGIO VOLTAGE VOLTAGE SPANNUNG	230 V	230 V
AMPERE AMPERE AMPÈRE AMPERE	2 A	2,1 A
POTENZA POWER PUISSANCE LEISTUNG	0,300 Kw	0,370 Kw
FREQUENZA FREQUENCY FRÉQUENCE FREQUENCY	50 Hz	50 Hz

DISPONIBILITÀ MOTORE TRIFASE
AVAILABILITY THREE PHASE MOTOR
DISPONIBILITÉ TRIPHASÉ MOTEUR
VERFÜGBARKEIT DREHSTROMMOTOR

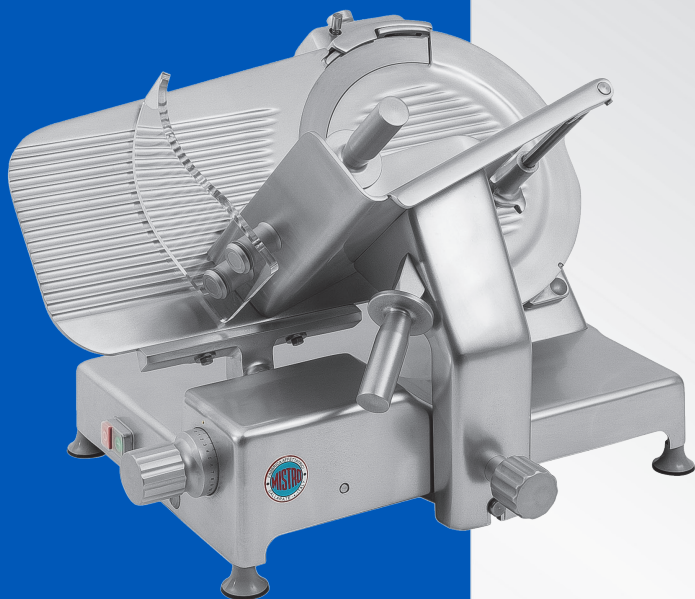
GM 350 CE

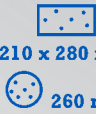

	GM 350 CE	GM 350 SA CE
LAMA - KNIFE - LAME - MESSER	350 mm	350 mm
SPESSORE DI TAGLIO CUTTING THICKNESS ÉPAISSEUR DE COUPE SCHNITTSTÄRKE	20 mm	20 mm
CAPACITÀ DI TAGLIO CUTTING CAPACITY CAPACITÉ DE COUPE DES PRODUITS SCHNEIDLEISTUNG	 210 x 280 mm 260 mm	 210 x 280 mm 260 mm
CORSA CARRELLO CARRIAGE STROKE COURSE CHARIOT WAGEN-HUB	320 mm	320 mm
PIATTO PLATE PLATEAU SCHNEIDEGUTAUFPLAGE	300x280 mm	300x280 mm
MISURE INGOMBRO OVERALL SIZE DIMENSIONS D'ENCOMBREMENT HÖCHSTABMESSUNGEN	793 x 610 x 485 mm	793 x 610 x 485 mm
BASE CENTRO PIEDI BASE FEET CENTRE BASE CENTRE PIEDS AUF STELL-FLÄCHE	553 x 395 mm	553 x 395 mm
PESO NETTO NET WEIGHT POIDS NET EIGEN-GEWICHT	43 Kg	43 Kg
MISURE IMBALLO PACKING SIZE DIMENSIONS EMBALLAGE ABMESSUNGEN VERPACKUNG	850 x 810 x 680 mm	850 x 810 x 680 mm
PESO LORDO GROSS WEIGHT POIDS BRUT BRUTTO GEWICHT	48 Kg	48 Kg

DISPONIBILITÀ MANOPOLE IN PLASTICA
AVAILABILITY PLASTIC KNOBS
DISPONIBILITÉ POIGNÉE EN PLASTIQUE
VERFÜGBARKEIT KUNSTOFF KNÖPFLE

GM 350 SA CE

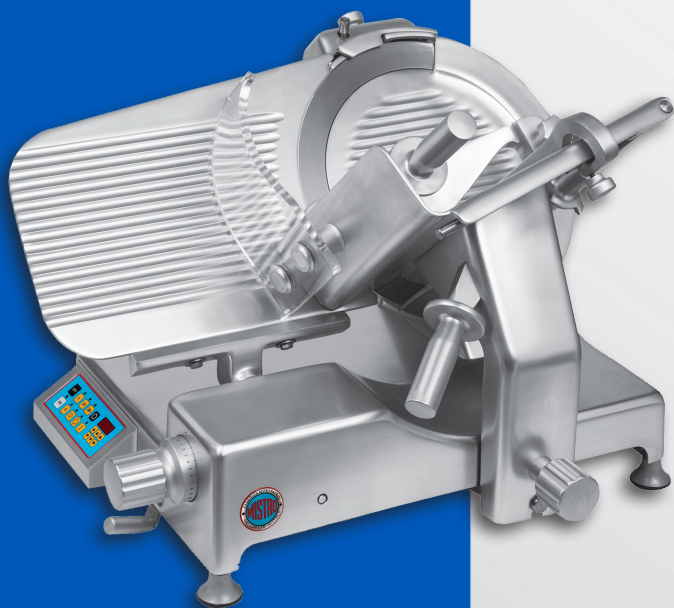



	GM 350 CE	GM 350 SA CE	GM 350 SA CE
MOTORE MOTOR MOTEUR MOTOR	MONOFASE SINGLE PHASE MONOPHASE EINPHASIG	MONOFASE SINGLE PHASE MONOPHASE EINPHASIG	CARRO WAGON CHARIOT ABLAGE
VOLTAGGIO VOLTAGE VOLTAGE SPANNUNG	230 V	230 V	OMRON
AMPERE AMPERE AMPÈRE AMPERE	1,2 A	1 A	1 A
POTENZA POWER PUISSANCE LEISTUNG	0,264 Kw	0,264 Kw	0,200 Kw
FREQUENZA FREQUENCY FRÉQUENCE FREQUENCY	50 Hz	50 Hz	50 Hz
TIPO TYPE TYPE TYPE	-	-	R7M- A20030-S1

DISPONIBILITÀ MOTORE TRIFASE
AVAILABILITY THREE PHASE MOTOR
DISPONIBILITÉ TRIPHASÉ MOTEUR
VERFÜGBARKEIT DREHSTROMMOTOR

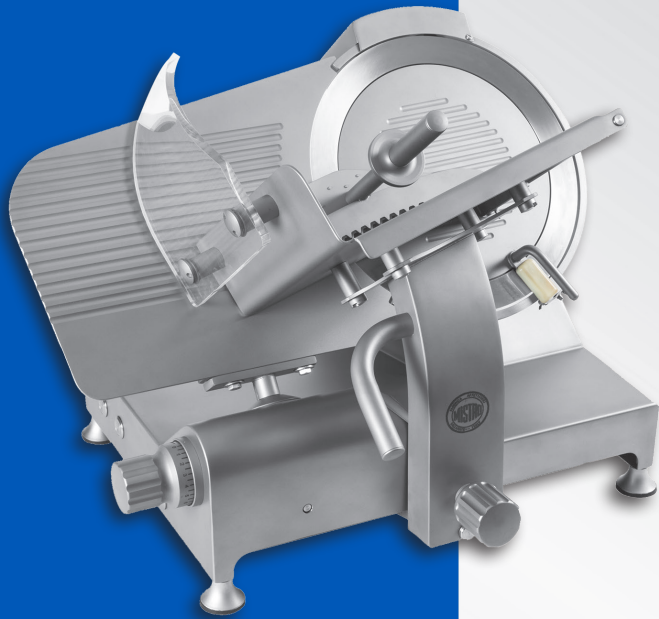
GSX 350 INOX CE



	GSX 350 INOX CE	GSX 350 INOX SA CE
LAMA - KNIFE - LAME - MESSER	350 mm	350 mm
SPESORE DI TAGLIO CUTTING THICKNESS ÉPAISSEUR DE COUPE SCHNITTSTÄRKE	15 mm	15 mm
CAPACITÀ DI TAGLIO CUTTING CAPACITY CAPACITÉ DE COUPE DES PRODUITS SCHNEIDLEISTUNG	 190 x 300 mm 240 mm	 190 x 300 mm 240 mm
CORSA CARRELLO CARRIAGE STROKE COURSE CHARIOT WAGEN-HUB	340 mm	340 mm
PIATTO PLATE PLATEAU SCHNEIDEGUTAUFLEGE	330x305 mm	330x305 mm
MISURE INGOMBRO OVERALL SIZE DIMENSIONS D'ENCOMBREMENT HÖCHSTABMESSUNGEN	570 x 780 x 520 mm	570 x 780 x 520 mm
BASE CENTRO PIEDI BASE FEET CENTRE BASE CENTRE PIEDS AUF STELL-FLÄCHE	400 x 545 mm	400 x 545 mm
PESO NETTO NET WEIGHT POIDS NET EIGEN-GEWICHT	53 Kg	60 Kg
MISURE IMBALLO PACKING SIZE DIMENSIONS EMBALLAGE ABMESSUNGEN VERPACKUNG	810 x 850 x 680 mm	810 x 850 x 680 mm
PESO LORDO GROSS WEIGHT POIDS BRUT BRUTTO GEWICHT	63 Kg	66 Kg

DISPONIBILITÀ VERSIONE CINGHIA E INGRANAGGI
AVAILABILITY BELT AND GEARS VERSION
DISPONIBILITÉ VERSION COURROIE ET PIGNON
VERFÜGBARKEIT VERSION RIEMEN UND ZAHNRÄDER

GSX 350 INOX SA CE

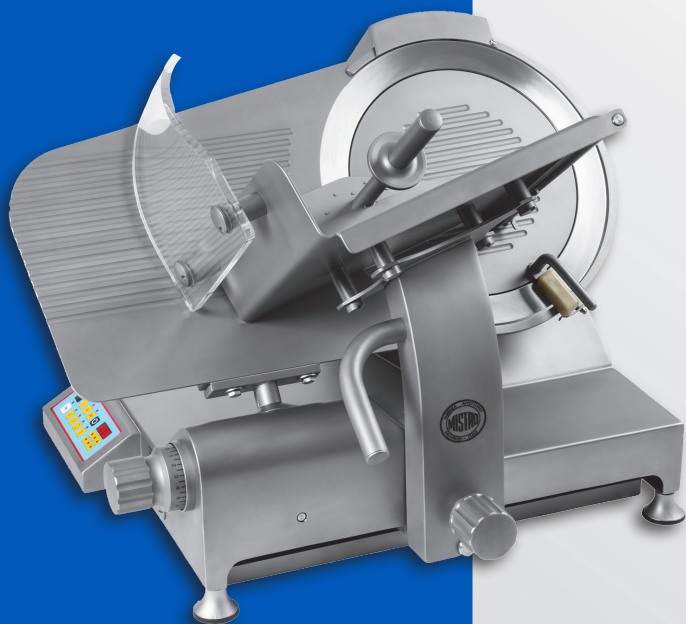



	GSX 350 INOX CE	GSX 350 INOX SA CE	GSX 350 INOX SA CE
MOTORE MOTOR MOTEUR MOTOR	MONOFASE SINGLE PHASE MONOPHASE EINPHASIG	MONOFASE SINGLE PHASE MONOPHASE EINPHASIG	CARRO WAGON CHARIOT ABLAGE
VOLTAGGIO VOLTAGE VOLTAGE SPANNUNG	230 V	230 V	220 V
AMPERE AMPERE AMPÈRE AMPERE	1,2 A	1,2 A	1,11 A
POTENZA POWER PUISSANCE LEISTUNG	0,264 Kw	0,264 Kw	200 W
FREQUENZA FREQUENCY FRÉQUENCE FREQUENCY	50 Hz	50 Hz	-
TIPO TYPE TYPE TYPE	-	-	Schneider BCH2

DISPONIBILITÀ MOTORE TRIFASE
AVAILABILITY THREE PHASE MOTOR
DISPONIBILITÉ TRIPHASÉ MOTEUR
VERFÜGBARKEIT DREHSTROMMOTOR

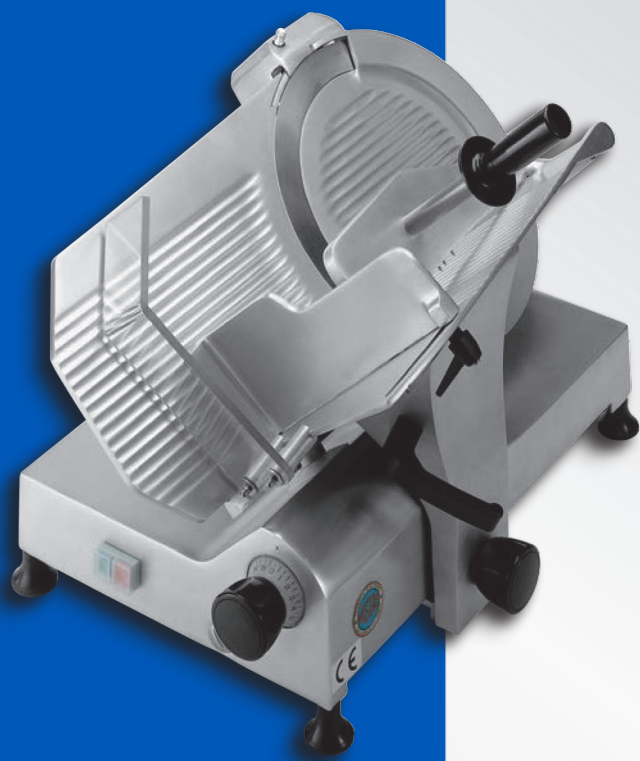
GS 350 I CE

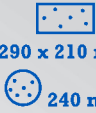

	GS 350 I CE	GS 350 SMI CE
LAMA - KNIFE - LAME - MESSER	350 mm	350 mm
SPESSORE DI TAGLIO CUTTING THICKNESS ÉPAISSEUR DE COUPE SCHNITTSTÄRKE	15 mm	15 mm
CAPACITÀ DI TAGLIO CUTTING CAPACITY CAPACITÉ DE COUPE DES PRODUITS SCHNEIDLEISTUNG	 290 x 210 mm 240 mm	 290 x 210 mm 240 mm
CORSA CARRELLO CARRIAGE STROKE COURSE CHARIOT WAGEN-HUB	340 mm	340 mm
PIATTO PLATE PLATEAU SCHNEIDEGUTAUFLEGE	310 x 290 mm	310 x 290 mm
MISURE INGOMBRO OVERALL SIZE DIMENSIONS D'ENCOMBREMENT HÖCHSTABMESSUNGEN	810 x 520 x 510 mm	810 x 520 x 525 mm
BASE CENTRO PIEDI BASE FEET CENTRE BASE CENTRE PIEDS AUF STELL-FLÄCHE	570 x 380 mm	570 x 380 mm
PESO NETTO NET WEIGHT POIDS NET EIGEN-GEWICHT	38 Kg	60 Kg
MISURE IMBALLO PACKING SIZE DIMENSIONS EMBALLAGE ABMESSUNGEN VERPACKUNG	850 x 640 x 680 mm	850 x 640 x 830 mm
PESO LORDO GROSS WEIGHT POIDS BRUT BRUTTO GEWICHT	42 Kg	64 Kg

GS 350 SMI CE



	GS 350 I CE	GS 350 SMI CE	GS 350 SMI CE
MOTORE MOTOR MOTEUR MOTOR	MONOFASE SINGLE PHASE MONOPHASE EINPHASIG	MONOFASE SINGLE PHASE MONOPHASE EINPHASIG	CARRO WAGON CHARIOT ABLAGE
VOLTAGGIO VOLTAGE VOLTAGE SPANNUNG	230 V	230 V	230/400 V
AMPERE AMPERE AMPÈRE AMPERE	1,2 A	1,2 A	-
POTENZA POWER PUISSANCE LEISTUNG	0,264 Kw	0,264 Kw	0,260 Kw
FREQUENZA FREQUENCY FRÉQUENCE FREQUENCY	50 Hz	50 Hz	50 Hz

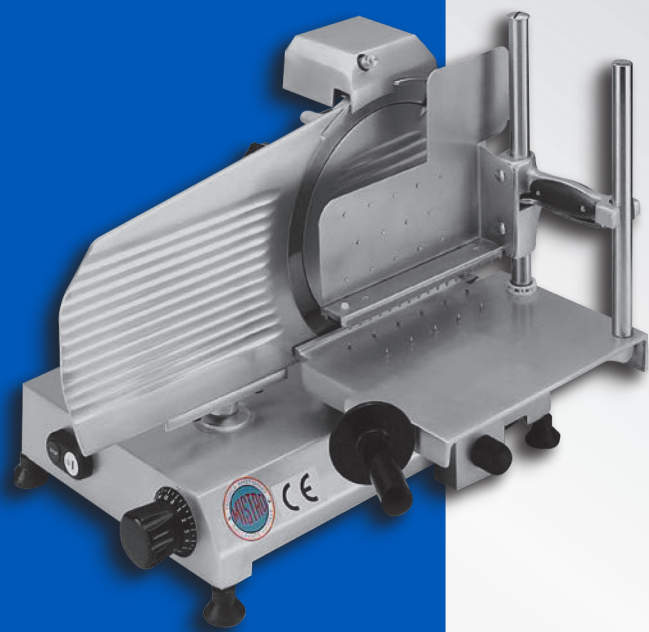

DISPONIBILITÀ MOTORE TRIFASE
AVAILABILITY THREE PHASE MOTOR
DISPONIBILITÉ TRIPHASE MOTEUR
VERFÜGBARKEIT DREHSTROMMOTOR

VM 250 E CE

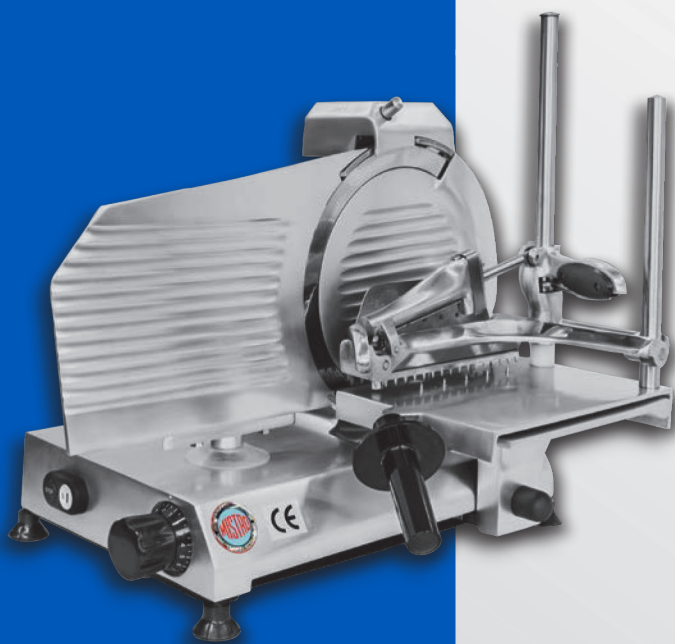

VM 250 E CE BRACCIO GRANDE



	VM 250 E CE	VM 250 E CE BRACCIO GRANDE
LAMA - KNIFE - LAME - MESSER	250 mm	250 mm
SPESORE DI TAGLIO CUTTING THICKNESS ÉPAISSEUR DE COUPE SCHNITTSTÄRKE	15 mm	15 mm
CAPACITÀ DI TAGLIO CUTTING CAPACITY CAPACITÉ DE COUPE DES PRODUITS SCHNEIDLEISTUNG	 180 x 220 mm 180 mm	 180 x 220 mm 180 mm
CORSA CARRELLO CARRIAGE STROKE COURSE CHARIOT WAGEN-HUB	260 mm	260 mm
PIATTO PLATE PLATEAU SCHNEIDEGUTAUFLEGE	230 x 230 mm	230 x 230 mm
MISURE INGOMBRO OVERALL SIZE DIMENSIONS D'ENCOMBREMENT HÖCHSTABMESSUNGEN	440 x 610 x 510 mm	440 x 610 x 510 mm
BASE CENTRO PIEDI BASE FEET CENTRE BASE CENTRE PIEDS AUF STELL-FLÄCHE	395 x 280 mm	395 x 280 mm
PESO NETTO NET WEIGHT POIDS NET EIGEN-GEWICHT	17,5 Kg	17,5 Kg
MISURE IMBALLO PACKING SIZE DIMENSIONS EMBALLAGE ABMESSUNGEN VERPACKUNG	660 x 550 x 500 mm	660 x 550 x 500 mm
PESO LORDO GROSS WEIGHT POIDS BRUT BRUTTO GEWICHT	21 Kg	21 Kg

	VM 250 E CE	VM 250 E CE BRACCIO GRANDE
MOTORE MOTOR MOTEUR MOTOR	MONOFASE SINGLE PHASE MONOPHASÉ EINPHASIG	MONOFASE SINGLE PHASE MONOPHASÉ EINPHASIG
VOLTAGGIO VOLTAGE VOLTAGE SPANNUNG	230 V	230 V
AMPERE AMPERE AMPÈRE AMPERE	0,8 A	0,8 A
POTENZA POWER PUISSANCE LEISTUNG	0,176 Kw	0,176 Kw
FREQUENZA FREQUENCY FRÉQUENCE FREQUENCY	50 Hz	50 Hz

VM 300 CE BRACCIO COLONNE



VM 300 CE BRACCIO CIGNO



VM 300 CE PIATTO CARNE

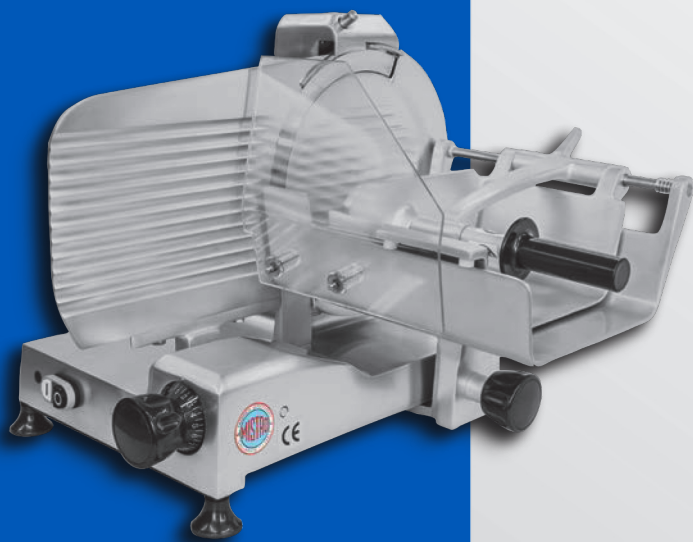



	VM 300 CE BRACCIO COLONNE	VM 300 CE BRACCIO CIGNO	VM 300 CE PIATTO CARNE
LAMA - KNIFE - LAME - MESSER	300 mm	300 mm	300 mm
SPESORE DI TAGLIO CUTTING THICKNESS ÉPAISSEUR DE COUPE SCHNITTSTÄRKE	16 mm	16 mm	16 mm
CAPACITÀ DI TAGLIO CUTTING CAPACITY CAPACITÉ DE COUPE DES PRODUITS SCHNEIDLEISTUNG	 200 x 260 mm  200 mm	 200 x 230 mm  200 mm	 200 x 240 mm  200 mm
CORSA CARRELLO CARRIAGE STROKE COURSE CHARIOT WAGEN-HUB	280 mm	280 mm	280 mm
PIATTO PLATE PLATEAU SCHNEIDEGUTAUFAGE	280 x 260 mm	280 x 260 mm	320 x 230 mm
MISURE INGOMBRO OVERALL SIZE DIMENSIONS D'ENCOMBREMENT HÖCHSTABMESSUNGEN	700 x 550 x 650 mm	770 x 530 x 730 mm	620 x 580 x 480 mm
BASE CENTRO PIEDI BASE FEET CENTRE BASE CENTRE PIEDS AUF STELL-FLÄCHE	440 x 330 mm	440 x 330 mm	440 x 330 mm
PESO NETTO NET WEIGHT POIDS NET EIGEN-GEWICHT	26 Kg	26 Kg	27 Kg
MISURE IMBALLO PACKING SIZE DIMENSIONS EMBALLAGE ABMESSUNGEN VERPACKUNG	650 x 550 x 570 mm	650 x 550 x 570 mm	790 x 620 x 510 mm
PESO LORDO GROSS WEIGHT POIDS BRUT BRUTTO GEWICHT	30 Kg	30 Kg	32 Kg

	VM 300 CE BRACCIO COLONNE	VM 300 CE BRACCIO CIGNO	VM 300 CE PIATTO CARNE
MOTORE MOTOR MOTEUR MOTOR	MONOFASE SINGLE PHASE MONOPHASE EINPHASIG	MONOFASE SINGLE PHASE MONOPHASE EINPHASIG	MONOFASE SINGLE PHASE MONOPHASE EINPHASIG
VOLTAGGIO VOLTAGE VOLTAGE SPANNUNG	230 V	230 V	230 V
AMPERE AMPERE AMPÈRE AMPERE	1 A	1 A	1 A
POTENZA POWER PUISSANCE LEISTUNG	0,220 Kw	0,220 Kw	0,220 Kw
FREQUENZA FREQUENCY FRÉQUENCE FREQUENCY	50 Hz	50 Hz	50 Hz

**DISPONIBILITÀ MOTORE TRIFASE
AVAILABILITY THREE PHASE MOTOR
DISPONIBILITÉ TRIPHASÉ MOTEUR
VERFÜGBARKEIT DREHSTROMMOTOR**

VM 350 P. SALUMI CE

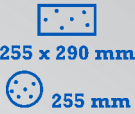

	VM 350 P. SALUMI CE	VM 350 P. CARNE CE
LAMA - KNIFE - LÄME - MESSER	350 mm	350 mm
SPESSORE DI TAGLIO CUTTING THICKNESS ÉPAISSEUR DE COUPE SCHNITTSTÄRKE	25 mm	25 mm
CAPACITÀ DI TAGLIO CUTTING CAPACITY CAPACITÉ DE COUPE DES PRODUITS SCHNEIDLEISTUNG	 255 x 290 mm 255 mm	 265 x 270 mm 265 mm
CORSA CARRELLO CARRIAGE STROKE COURSE CHARIOT WAGEN-HUB	320 mm	340 mm
PIATTO PLATE PLATEAU SCHNEIDEGUTAUFBLAGE	300x340 mm	425x270 mm
MISURE INGOMBRO OVERALL SIZE DIMENSIONS D'ENCOMBREMENT HÖCHSTABMESSUNGEN	830 x 600 x 790 mm	730 x 670 x 570 mm
BASE CENTRO PIEDI BASE FEET CENTRE BASE CENTRE PIEDS AUF STELL-FLÄCHE	555 x 395 mm	555 x 395 mm
PESO NETTO NET WEIGHT POIDS NET EIGEN-GEWICHT	43 Kg	46 Kg
MISURE IMBALLO PACKING SIZE DIMENSIONS EMBALLAGE ABMESSUNGEN VERPACKUNG	850 x 810 x 680 mm	850 x 810 x 680 mm
PESO LORDO GROSS WEIGHT POIDS BRUT BRUTTO GEWICHT	48 Kg	50 Kg

DISPONIBILITÀ MANOPOLE IN PLASTICA
AVAILABILITY PLASTIC KNOBS
DISPONIBILITÉ POIGNÉE EN PLASTIQUE
VERFÜGBARKEIT KUNSTOFF KNÖPFE

VM 350 P. CARNE CE

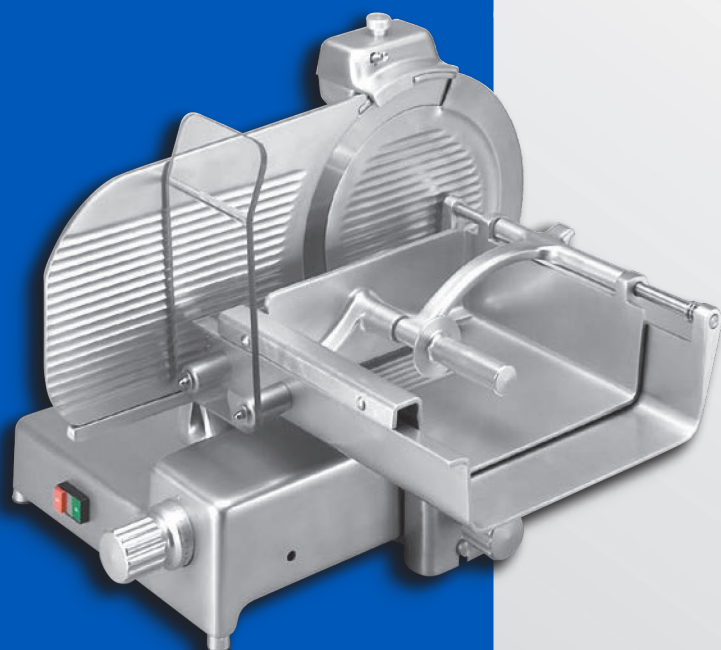

	VM 350 P. SALUMI CE	VM 350 P. CARNE CE
MOTORE MOTOR MOTEUR MOTOR	MONOFASE SINGLE PHASE MONOPHASE EINPHASIG	MONOFASE SINGLE PHASE MONOPHASE EINPHASIG
VOLTAGGIO VOLTAGE VOLTAGE SPANNUNG	230 V	230 V
AMPERE AMPERE AMPÈRE AMPERE	1,2 A	1,2 A
POTENZA POWER PUISSANCE LEISTUNG	0,264 Kw	0,264 Kw
FREQUENZA FREQUENCY FRÉQUENCE FREQUENCY	50 Hz	50 Hz

DISPONIBILITÀ MOTORE TRIFASE
AVAILABILITY THREE PHASE MOTOR
DISPONIBILITÉ TRIPHASE MOTEUR
VERFÜGBARKEIT DREHSTROMMOTOR



SEGAOSSA 1400 / 1600

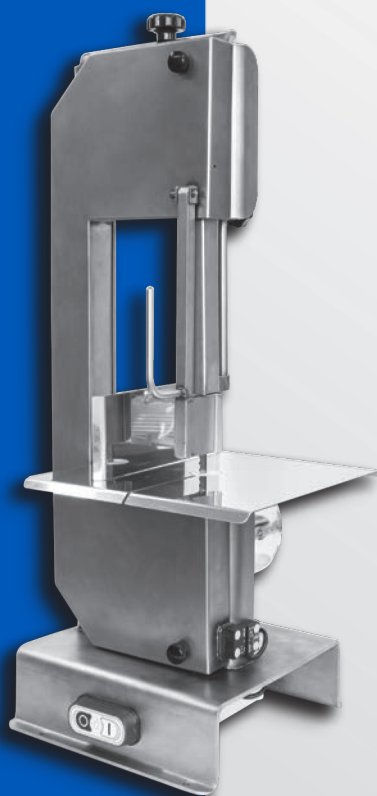

SEGAOSSA 1400 / 1600 CE



	SEGAOSSA 1400	SEGAOSSA 1600
SVILUPPO LAMA DEVELOPMENT BLADE DÉVELOPPEMENT DE LA LÂME ENTWICKLUNGSKLINGE	1400x16x0,50 mm 3 TPI	1600x16x0,50 mm 3 TPI
CAPACITÀ DI TAGLIO CUTTING CAPACITY CAPACITÉ DE COUPE DES PRODUITS SCHNEIDLEISTUNG	 160 x 200 mm	 160 x 300 mm
MISURE INGOMBRO OVERALL SIZE DIMENSIONS D'ENCOMBREMENT HÖCHSTABMESSUNGEN	h720 x 360 x 420 mm	h850 x 360 x 420 mm
PESO NETTO NET WEIGHT POIDS NET EIGEN-GEWICHT	22,5 Kg	28 Kg
MISURE IMBALLO PACKING SIZE DIMENSIONS EMBALLAGE ABMESSUNGEN VERPACKUNG	h480 x 550 x 820 mm	h480 x 550 x 930 mm
PESO LORDO GROSS WEIGHT POIDS BRUT BRUTTO GEWICHT	27,5 Kg	32,5 Kg

	SEGAOSSA 1400 CE	SEGAOSSA 1600 CE
SVILUPPO LAMA DEVELOPMENT BLADE DÉVELOPPEMENT DE LA LÂME ENTWICKLUNGSKLINGE	1400x16x0,50 mm 3 TPI	1600x16x0,50 mm 3 TPI
CAPACITÀ DI TAGLIO CUTTING CAPACITY CAPACITÉ DE COUPE DES PRODUITS SCHNEIDLEISTUNG	 160 x 200 mm	 160 x 300 mm
MISURE INGOMBRO OVERALL SIZE DIMENSIONS D'ENCOMBREMENT HÖCHSTABMESSUNGEN	h870 x 400 x 400 mm	h940 x 400 x 400 mm
PESO NETTO NET WEIGHT POIDS NET EIGEN-GEWICHT	31 Kg	36 Kg
MISURE IMBALLO PACKAGE SIZE DIMENSIONS EMBALLAGE ABMESSUNGEN VERPACKUNG	h480 x 550 x 1000 mm	h480 x 550 x 1010 mm
PESO LORDO GROSS WEIGHT POIDS BRUT BRUTTO GEWICHT	36 Kg	41 Kg

	SEGAOSSA 1400 SEGAOSSA 1400 CE	SEGAOSSA 1600 SEGAOSSA 1600 CE
MOTORE MOTOR MOTEUR MOTOR	MONOFASE SINGLE PHASE MONOPHASE EINPHASIG	MONOFASE SINGLE PHASE MONOPHASE EINPHASIG
VOLTAGGIO VOLTAGE VOLTAGE SPANNUNG	230 V	230 V
AMPERE AMPERE AMPÈRE AMPERE	2,6 A	3,8 A
POTENZA POWER PUISSANCE LEISTUNG	0,580 Kw	0,750 Kw
FREQUENZA FREQUENCY FRÉQUENCE FREQUENCY	50 Hz	50 Hz
GIRI RPM RPM MOTRUMDREHUNGEN	1450	1400

DISPONIBILITÀ MOTORE TRIFASE
AVAILABILITY THREE PHASE MOTOR
DISPONIBILITÉ TRIPHASE MOTEUR
VERFÜGBARKEIT DREHSTROMMOTOR

INSACCATRICE



INSACCATRICE	
CAPACITÀ CAPACITY CAPACITÉ FASSUNGSVERMÖGEN	8 Lt.
TUBI DUCT TUBES ROHRE	18 mm 23 mm 30 mm 35 mm
MISURE INGOMBRO OVERALL SIZE DIMENSIONS D'ENCOMBREMENT HÖCHSTABMESSUNGEN	730 x 355 x 215 h mm
PESO NETTO NET WEIGHT POIDS NET EIGEN-GEWICHT	16 Kg
MISURE IMBALLO PACKAGE SIZE DIMENSIONS EMBALLAGE ABMESSUNGEN VERPACKUNG	800 x 300 x 300 h mm
PESO LORDO GROSS WEIGHT POIDS BRUTTO GEWICHT	17 Kg

PRESSA HAMBURGER



PRESSA HAMBURGER		
DIAMETRO DIAMETER DIAMÈTRE DURCHMESSER	100 mm	130 mm
MISURE INGOMBRO OVERALL SIZE DIMENSIONS D'ENCOMBREMENT HÖCHSTABMESSUNGEN	315 x 300 x 300 mm	330 x 300 x 300 mm
PESO NETTO NET WEIGHT POIDS NET EIGEN-GEWICHT	4 Kg	4,5 Kg
MISURE IMBALLO PACKAGE SIZE DIMENSIONS EMBALLAGE ABMESSUNGEN VERPACKUNG	320 x 270 x 270 mm	320 x 270 x 270 mm
PESO LORDO GROSS WEIGHT POIDS BRUTTO GEWICHT	5 Kg	5,5 Kg

AFFETTATRICE A VOLANO MA 300



AFFETTATRICE A VOLANO	
LAMA - KNIFE - LAME - MESSER	300 mm
SPESORE MINIMO DI TAGLIO MINIMUM CUTTING THICKNESS MINIMUM ÉPAISSEUR DE COUPE MINIMUM SCHNITTSTÄRKE	0,3 mm
SPESORE DI TAGLIO CUTTING THICKNESS ÉPAISSEUR DE COUPE SCHNITTSTÄRKE	5 mm
CAPACITÀ DI TAGLIO CUTTING CAPACITY CAPACITÉ DE COUPE DES PRODUITS SCHNEIDLEISTUNG	190 x 235 mm
CORSA CARRELLO CARRIAGE STROKE COURSE CHARIOT WAGEN-HUB	285 mm
PIATTO INOX STAINLESS STEEL PLATE PLATEAU INOX SCHNEIDEGUTAUFBLAGE EDELSTAHL	235 x 180 mm
MISURE INGOMBRO AFFETTATRICE OVERALL SIZE SLICER DIMENSIONS D'ENCOMBREMENT TRANCHEUR HÖCHSTABMESSUNGEN AUFSCHNITTMASCHINE	840 x 620 x 550 h mm
MISURE INGOMBRO PIEDISTALLO OVERALL SIZE PEDESTAL DIMENSIONS D'ENCOMBREMENT PIETEMENT HÖCHSTABMESSUNGEN SOCKEL	Ø 570 x 780 mm
MISURE INGOMBRO AFFETTATRICE + PIEDISTALLO OVERALL SIZE SLICER + PEDESTAL DIMENSIONS D'ENCOMBREMENT TRANCHEUR + PIETEMENT HÖCHSTABMESSUNGEN AUFSCHNITTMASCHINE + SOCKEL	840 x 620 x 1330 h mm
PESO NETTO AFFETTATRICE NET WEIGHT SLICER POIDS NET TRANCHEUR EIGEN-GEWICHT SCHNEIDER MASCHINE	73 Kg
PESO NETTO PIEDISTALLO NET WEIGHT PEDESTAL POIDS NET PIETEMENT EIGEN-GEWICHT SOCKEL	48 Kg

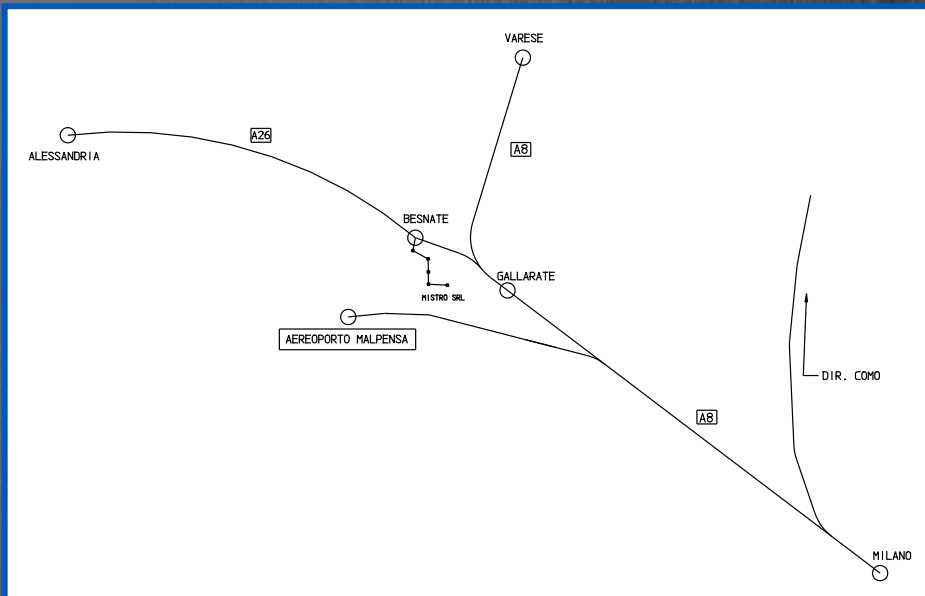

MISTRO S.r.l.
21013 GALLARATE (VA) - ITALY
Via Assisi, 30
Tel. 0331-776148 r.a.
Fax 0331-774668
www.mistro.it
E-mail: info@mistro.it

La ditta Mistro S.r.l si riserva il diritto di apportare eventuali variazioni e/o modifiche senza alcun preavviso. Le foto sono esclusivamente ad uso pubblicitario. Mistro S.r.l. company reserves the right to make variations and/or changes without forwarning. The photos are only for advertisement.

La société Mistro S.r.l. se réserve le droit de faire des changements ou des modifications sans préavis. Les photos ne sont que pour la publicité.

Das Unternehmen Mistro S.r.l behält sich das Recht vor, Änderungen ohne vorherige Ankündigung zu machen. Die Fotos sind ausschließlich für Werbezwecke.